

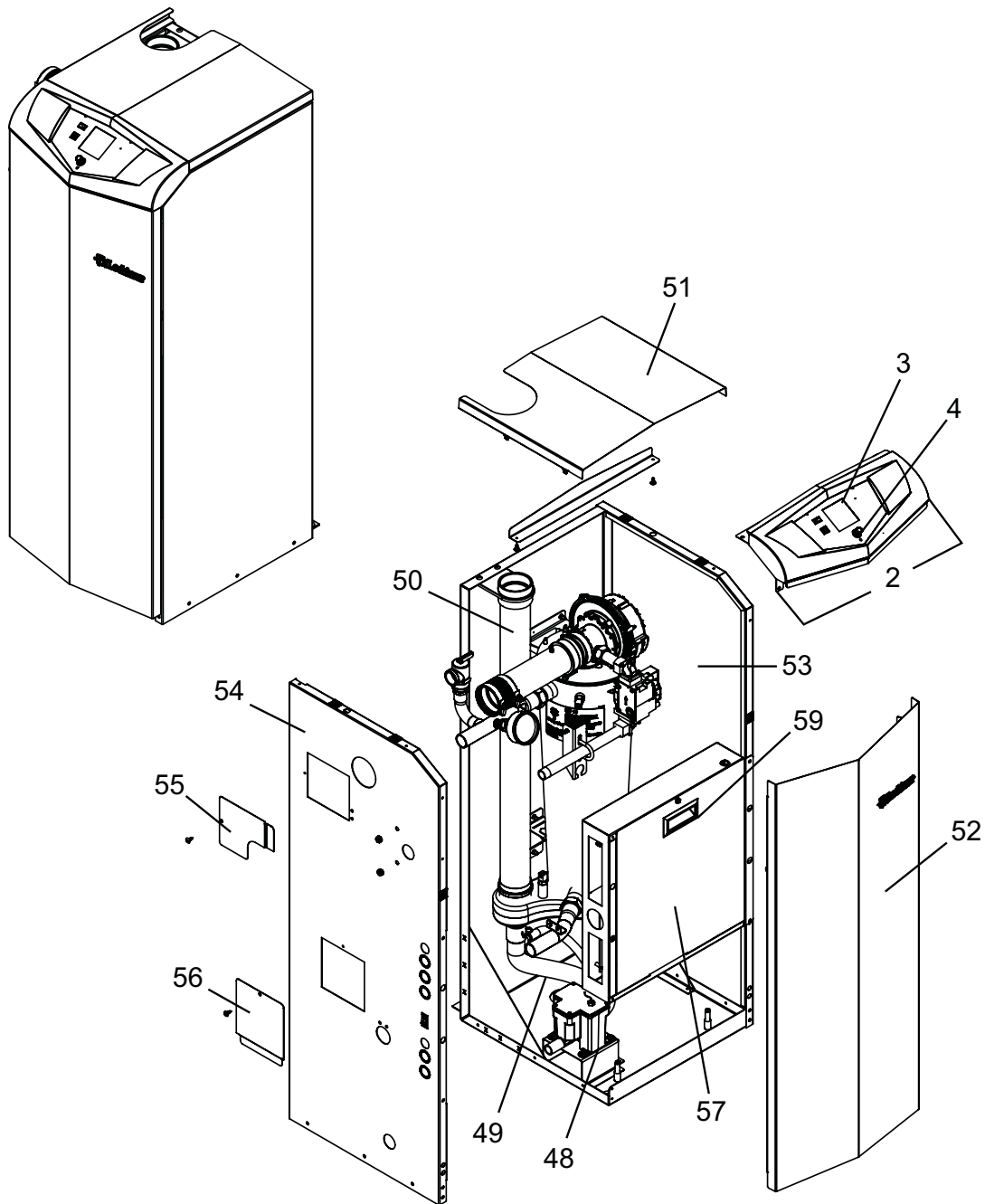

PARTS & SERVICE DEPARTMENT
 Nashville, Tennessee
 877-554-5544 • Fax: 615-547-1000
 parts_team@lochinvar.com
 www.Lochinvar.com

Replacement Parts List

Knight
AQUAS Fire Tube Commercial Pool Package
AP 285



GAS TRAIN

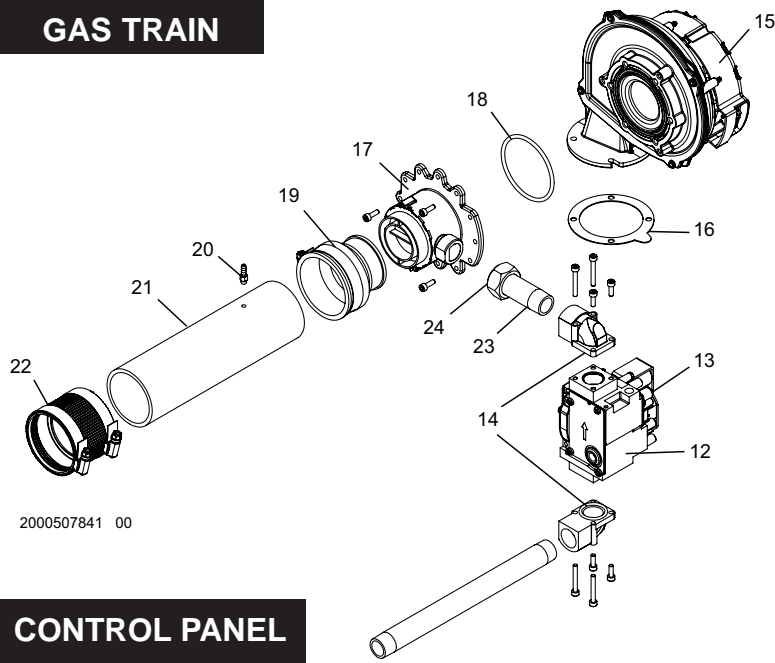

2000507841 00

HEAT EXCHANGER

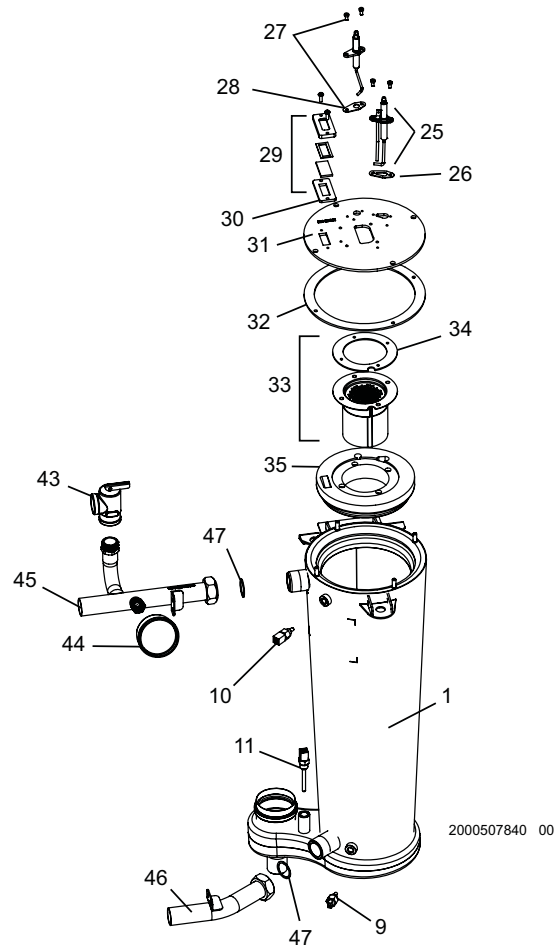

2000507840 00

CONTROL PANEL

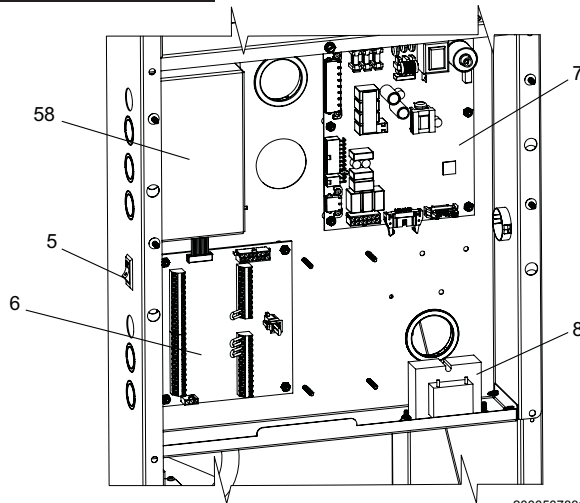

2000507836 00

INDIRECT HEAT EXCHANGER

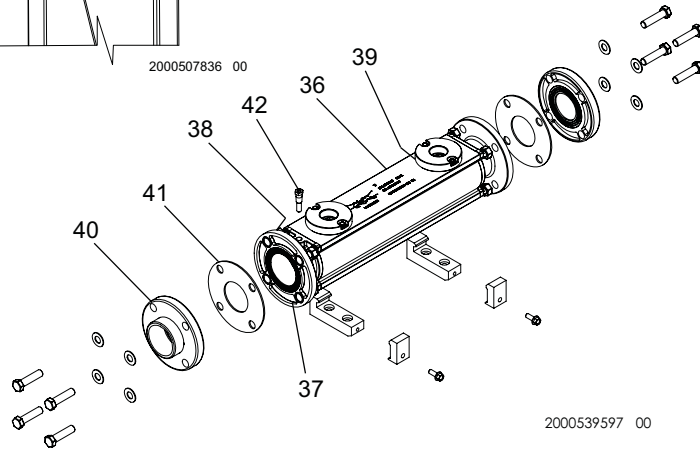

2000539597 00

ITEM NO.	PART NO.	DESCRIPTION	MODEL
HEAT EXCHANGER ASSEMBLY			
1	100266971	HEAT EXCHANGER - ASME - H STAMP - 285 MBH	AP 285
CONTROLS			
2	100281358	DISPLAY BEZEL	AP 285
3	100278134*	USER INTERFACE CONTROL	AP 285
4	100277824	KNOB, FLUTED W/ SKIRT	AP 285
5	100208242	SWITCH, POWER ON/OFF	AP 285
6	100277940*	LOW VOLTAGE CONNECTION BOARD	AP 285
7	100281359*	INTEGRATED CONTROL BOARD	AP 285
7	100281383	INTEGRATED CONTROL BOARD, HIGH ALTITUDE	AP 285
7	100281360	INTEGRATED CONTROL BOARD, CANADIAN	AP 285
7	100281382	INTEGRATED CONTROL BOARD, SPA	AP 285
7	100281381	INTEGRATED CONTROL BOARD, SPA, HIGH ALTITUDE	AP 285

PLEASE HAVE MODEL AND SERIAL NUMBER WHEN ORDERING PARTS
*ITEMS DENOTE SUGGESTED INVENTORY PARTS

ITEM NO.	PART NO.	DESCRIPTION	MODEL
CONTROLS (CONTINUED)			
8	100276391	TRANSFORMER, 24V, 40VA	AP 285
9	100208560*	INLET SENSOR	AP 285
10	100208547*	OUTLET SENSOR / HIGH LIMIT	AP 285
11	100208556*	FLUE SENSOR	AP 285
GAS TRAIN			
12	100268033	GAS VALVE ASSEMBLY	AP 285
13	100267005	SWITCH, GAS VALVE ON/OFF	AP 285
14	100275534	FLANGE, GAS VALVE W/ O-RING GASKET	AP 285
15	100267000	FAN ASSEMBLY	AP 285
16	100208101*	GASKET, FAN	AP 285
17	100287142	VENTURI, NAT	AP 285
17	100287123	VENTURI, LP	AP 285
18	100208761*	GASKET, VENTURI	AP 285
19	100287122	COUPLING, AIR INLET	AP 285
20	100208326	HOSE BARB, BRASS	AP 285
21	100290058	AIR INTAKE CONNECTION, 2" x 8" PVC	AP 285
22	100275561	COUPLING, AIR INLET	AP 285
23	100275537	UNION ADAPTER	AP 285
24	100289510	UNION ADAPTER GASKET	AP 285
PILOT & BURNER ASSEMBLIES			
25	100165925*	IGNITOR W/ GASKET	AP 285
26	100208086*	GASKET, IGNITOR	AP 285
27	100165930*	FLAME SENSOR W/ GASKET	AP 285
28	100208091*	GASKET, FLAME SENSOR	AP 285
29	100189215*	SIGHT GLASS KIT	AP 285
30	100275566	GASKET, SIGHT GLASS	AP 285
31	100268113	HEAT EXCHANGER TOP PLATE ASSEMBLY	AP 285
32	100287094*	GASKET, HEAT EXCHANGER TOP PLATE	AP 285
33	100267968	BURNER W/ GASKET	AP 285
34	100287090*	GASKET, BURNER	AP 285
35	100287086*	INSULATION, TOP PLATE	AP 285
INDIRECT HEAT EXCHANGER			
36	100293776	INDIRECT HEAT EXCHANGER	AP 285
37	100295651	KIT, END CAP FLANGE, 2-1/2"	AP 285
38	100295661	KIT, O-RING, 97.79 X 5.33, END CAP	AP 285
39	100295656	KIT, O-RING, 63.09 X 3.53, BOILER CONNECTION	AP 285
40	100293917	FLANGE	AP 285
41	100293918*	GASKET, FLANGE	AP 285
42	100208569*	BULBWELL	AP 285
MISCELLANEOUS			
43	100284289	RELIEF VALVE, 30 PSI	AP 285
44	100208152*	GAUGE, TRIOMETER, 75# PSI	AP 285
45	100290113	WATER TUBE, OUTLET	AP 285
46	100278040	WATER TUBE, INLET	AP 285
47	100287070	GASKET, WATER TUBE	AP 285
48	100284709	CONDENSATE TRAP ASSEMBLY	AP 285
49	100290105	HOSE ASSEMBLY, CONDENSATE TRAP	AP 285
50	100289713	FLUE CONNECTION PIPE, 3" CPVC	AP 285
-	100208808*	FUSE, TIME DELAY, 0.8 AMP	AP 285
-	100208231*	FUSE, TIME DELAY, 3.15 AMP	AP 285
-	100208232*	FUSE, TIME DELAY, 5 AMP	AP 285
-	100289551	BIRD SCREEN, 3" PVC	AP 285
-	100208569*	BULBWELL, 1/4"	AP 285
-	100208552*	SENSOR, SYSTEM	AP 285
-	100286981	HARNESS, CONNECTION BOARD	AP 285
-	100278061	HARNESS, FLAME SENSE ELECTRODE	AP 285
-	100208620	HARNESS, SPARK ELECTRODE	AP 285
-	100286984	HARNESS, POWER CONTROL	AP 285
-	100290103	HARNESS, UNIT CONTROL	AP 285
-	100208638	CABLE, RIBBON	AP 285
-	100208653*	FLOW SWITCH	AP 285
-	100208652*	LOW WATER CUT OFF, MR W/ TEST	AP 285

PLEASE HAVE MODEL AND SERIAL NUMBER WHEN ORDERING PARTS

*ITEMS DENOTE SUGGESTED INVENTORY PARTS

ITEM NO.	PART NO.	DESCRIPTION	MODEL
MISCELLANEOUS (CONTINUED)			
-	100157719	KIT, ALARM BELL	AP 285
-	100209659	KIT, INSTALL	AP 285
-	100157718*	KIT, SYSTEM SENSOR	AP 285
-	100157610	KIT, SIDEWALL VENT - 3"	AP 285
-	100157611	KIT, SIDEWALL VENT - 4"	AP 285
-	100268109	KIT, LP CONVERSION	AP 285
-	100287027	TEE, 3" CPVC W/ ANALYZER PORT	AP 285
PUMPS			
-	100277714	PUMP ASSEMBLY - 1/6 HP, 1-1/4" FLANGE, CAST	AP 285
JACKET ASSEMBLY			
51	100281386	JACKET, OUTER TOP ASSEMBLY	AP 285
52	100281388	JACKET, OUTER FRONT ASSEMBLY	AP 285
53	100281389	JACKET, OUTER RIGHT ASSEMBLY	AP 285
54	100281390	JACKET, OUTER LEFT ASSEMBLY	AP 285
55	100281376	WATER OUTLET COVER PANEL	AP 285
56	100281375	FLUE SENSOR COVER PANEL	AP 285
57	100281373	CONTROL PANEL COVER	AP 285
58	100281372	JUNCTION BOX COVER	AP 285
59	100288542	DOOR HANDLE	AP 285
-	100208308*	DOOR CATCH	AP 285
-	100208818*	DOOR STRIKE	AP 285

PLEASE HAVE MODEL AND SERIAL NUMBER WHEN ORDERING PARTS
*ITEMS DENOTE SUGGESTED INVENTORY PARTS