

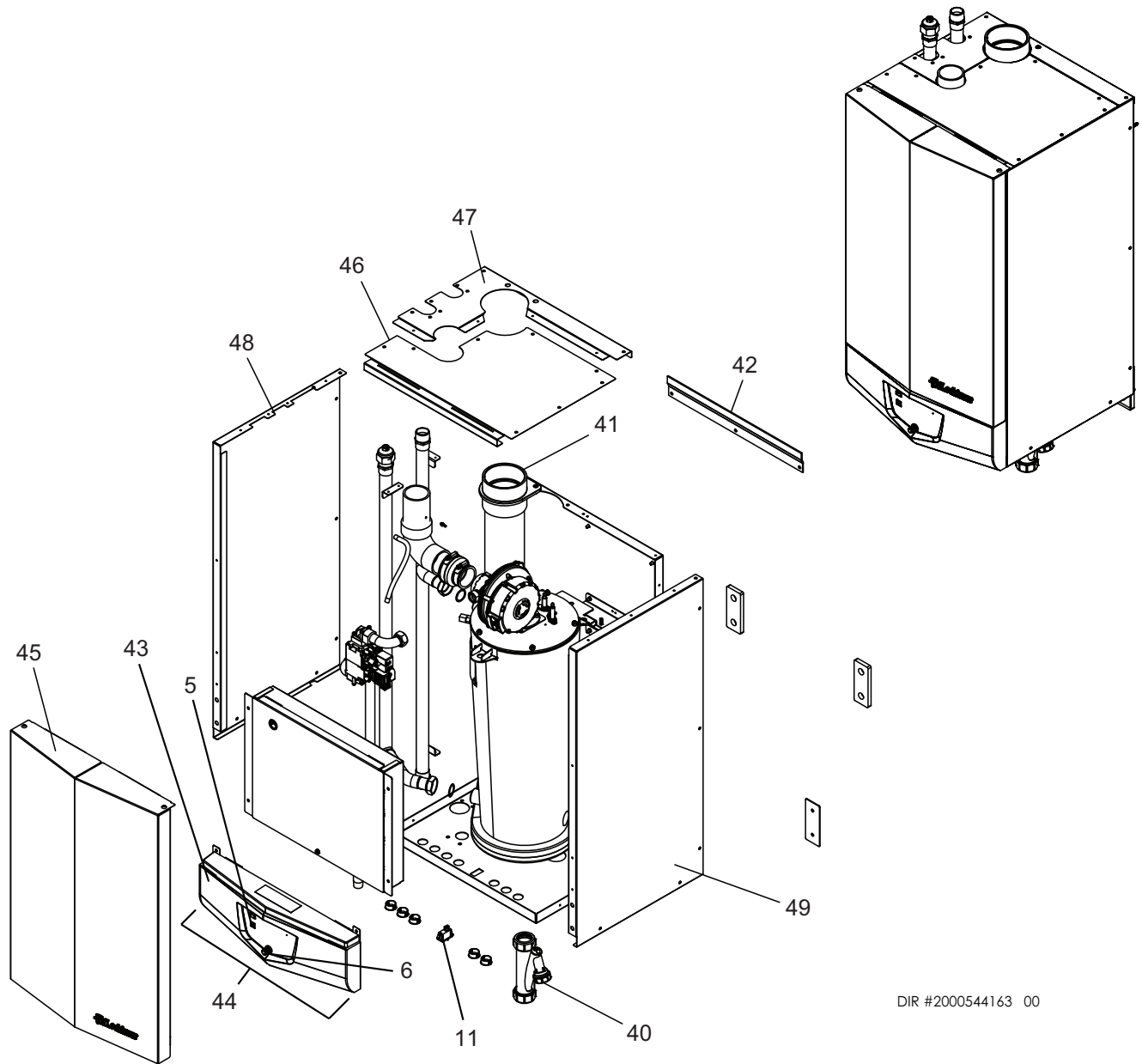

Replacement Parts List

PARTS & SERVICE DEPARTMENT
 Nashville, Tennessee
 877-554-5544 • Fax: 615-882-2918
 parts_team@lochinvar.com
 www.Lochinvar.com

Knight
Wall Mount Boilers
WH 56 thru 400



DIR #2000544163 00

CONTROL PANEL

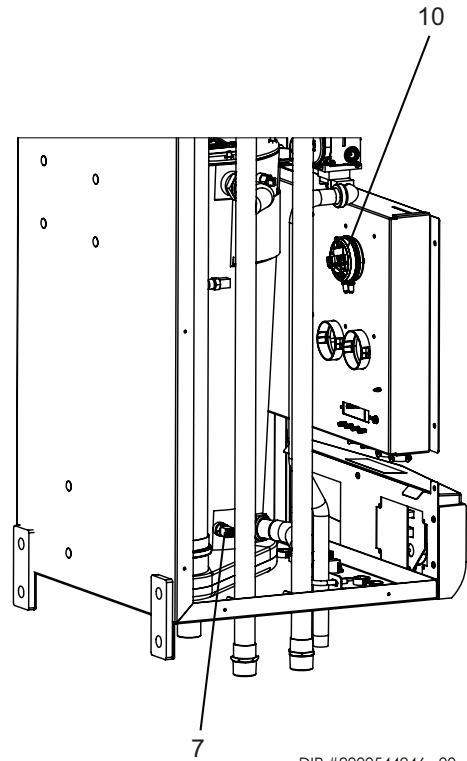
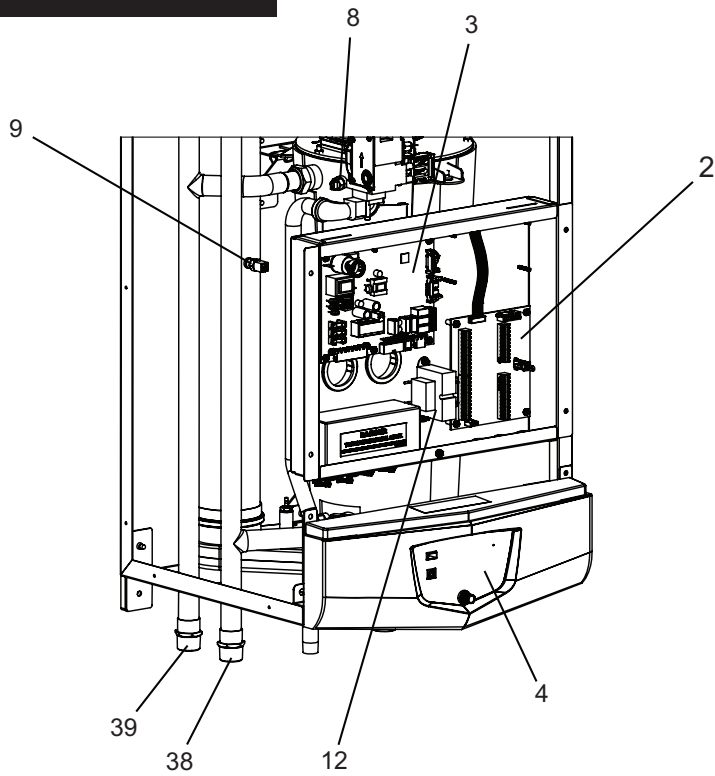

DIR #2000544246 00

GAS TRAIN

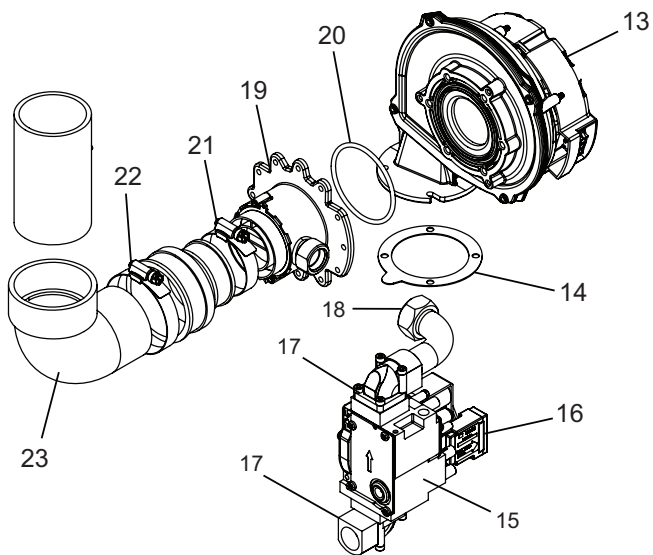

DIR #2000544243 00

HEAT EXCHANGER

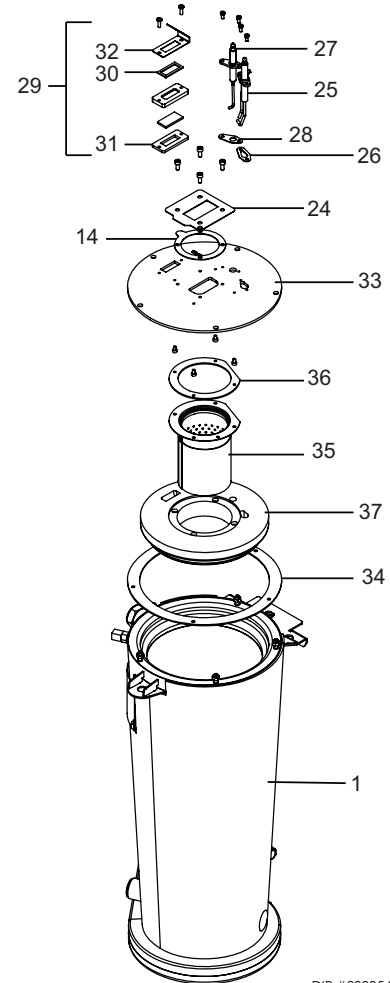

DIR #2000544240 00

ITEM NO.	PART NO.	DESCRIPTION	MODEL
HEAT EXCHANGER ASSEMBLY			
1	100266940	HEAT EXCHANGER ASSEMBLY	WH 056
1	100266951	HEAT EXCHANGER ASSEMBLY	WH 086
1	100266953	HEAT EXCHANGER ASSEMBLY	WH 111
1	100266958	HEAT EXCHANGER ASSEMBLY	WH 156
1	100266959	HEAT EXCHANGER ASSEMBLY	WH 200
1	100266971	HEAT EXCHANGER ASSEMBLY	WH 286
1	100147340	HEAT EXCHANGER ASSEMBLY	WH 400
CONTROLS			
2	100277940*	CONNECTION BOARD	WH 056 - 400
3	100286874*	CONTROL BOARD, MAIN	WH 056
3	100286875*	CONTROL BOARD, MAIN	WH 086
3	100286877*	CONTROL BOARD, MAIN	WH 111
3	100286880*	CONTROL BOARD, MAIN	WH 156
3	100286923*	CONTROL BOARD, MAIN	WH 200
3	100287207*	CONTROL BOARD, MAIN	WH 286
3	100287205*	CONTROL BOARD, MAIN	WH 400
3	100287202	CONTROL BOARD, MAIN - HIGH ALTITUDE	WH 056
3	100287201	CONTROL BOARD, MAIN - HIGH ALTITUDE	WH 086
3	100287188	CONTROL BOARD, MAIN - HIGH ALTITUDE	WH 111
3	100287187	CONTROL BOARD, MAIN - HIGH ALTITUDE	WH 156
3	100287185	CONTROL BOARD, MAIN - HIGH ALTITUDE	WH 200
3	100287182	CONTROL BOARD, MAIN - HIGH ALTITUDE	WH 286
3	100287159	CONTROL BOARD, MAIN - HIGH ALTITUDE	WH 400
4	100278134	CONTROL BOARD, USER INTERFACE	ALL
5	100287157	LABEL, CONTROL OVERLAY	ALL
6	100277824	KNOB, FLUTED	ALL
7	100208560	SENSOR, INLET	ALL
8	100208547	SENSOR, OUTLET	ALL
9	100287156	SENSOR, FLUE W/ GROMMET	ALL
10	100287155	SWITCH, PRESSURE - 3.2" WATER COLUMN	WH 056 - 156
10	100287154	SWITCH, PRESSURE - 4.1" WATER COLUMN	WH 200 - 286
10	100289703	SWITCH, PRESSURE - 5.3" WATER COLUMN	WH 400
11	100208242	SWITCH, POWER - ON / OFF	ALL
12	100208230	TRANSFORMER, 120 VAC X 24 VAC, 40 VA, 60 HZ	ALL
GAS TRAIN			
13	100266999	FAN W/ GASKETS	WH 056 - 156
13	100275531	FAN W/ GASKETS	WH 200 - 286
13	100145008	FAN W/ GASKETS	WH 400
14	100208101	GASKET, BLOWER	ALL
15	100268028	GAS VALVE W/ GASKET	WH 056
15	100268029	GAS VALVE W/ GASKET	WH 086
15	100268030	GAS VALVE W/ GASKET	WH 111
15	100268031	GAS VALVE W/ GASKET	WH 156
15	100268032	GAS VALVE W/ GASKET	WH 200
15	100268033	GAS VALVE W/ GASKET	WH 286
15	100171950	GAS VALVE W/ VENTURI AND GASKETS	WH 400
16	100275533	SWITCH, GAS VALVE - ON / OFF	WH 056 - 286
17	100275534	FLANGE, GAS VALVE W/ GASKET	WH 056 - 286
17	100287896	FLANGE, GAS VALVE W/ GASKET	WH 400
18	100287150	ADAPTER, GAS VALVE UNION W/ GASKET	WH 056 - 286
-	100275538	GASKET, GAS VALVE UNION	WH 056 - 286
19	100287149	VENTURI, NATURAL	WH 056 - 086
19	100287147	VENTURI, NATURAL	WH 111
19	100287145	VENTURI, NATURAL	WH 156
19	100287143	VENTURI, NATURAL	WH 200
19	100287142	VENTURI, NATURAL	WH 286
19	100287130	VENTURI, LP	WH 056
19	100287129	VENTURI, LP	WH 086
19	100287127	VENTURI, LP	WH 111
19	100287126	VENTURI, LP	WH 156

PLEASE HAVE MODEL AND SERIAL NUMBER WHEN ORDERING PARTS
*ITEMS DENOTE SUGGESTED INVENTORY PARTS

ITEM NO.	PART NO.	DESCRIPTION	MODEL
GAS TRAIN (CONTINUED)			
19	100287124	VENTURI, LP	WH 200
19	100287123	VENTURI, LP	WH 286
20	100277743*	GASKET, VENTURI O-RING	WH 056 - 156
20	100208761*	GASKET, VENTURI O-RING	WH 200 - 400
21	100275550	COUPLING, VENTURI W/ CLAMP	WH 056 - 200
21	100287122	COUPLING, VENTURI W/ CLAMPS	WH 286 - 400
22	100287121	COUPLING, AIR INLET	WH 056 - 086
22	100275561	COUPLING, AIR INLET	WH 111 - 286
22	100287120	COUPLING, AIR INLET	WH 400
-	100208326	HOSE BARB, BRASS	ALL
23	100287118	AIR INLET, ELBOW	WH 056 - 086, 156
23	100287117	AIR INLET, ELBOW	WH 111
23	100287116	AIR INLET, ELBOW	WH 200
23	100287115	AIR INLET, ELBOW	WH 286
23	100287114	AIR INLET, ELBOW	WH 400
24	100287025	AIR SHUTTER W/ GASKETS, LP	WH 056 - 086
24	100287022	AIR SHUTTER W/ GASKETS, LP	WH 111
24	100287020	AIR SHUTTER W/ GASKETS, LP	WH 156
24	100284239	AIR SHUTTER W/ GASKETS, LP	WH 200 - 286
-	100287017	KIT, ORIFICE, LP	WH 111
-	100287011	KIT, ORIFICE, LP	WH 156 - 200
IGNITION & BURNER ASSEMBLIES			
25	100165925*	IGNITOR W/ GASKET & SCREWS	ALL
26	100208086*	GASKET, IGNITOR	ALL
27	100165930*	FLAME SENSOR W/ GASKET & SCREWS	ALL
28	100208091*	GASKET, FLAME SENSOR	ALL
29	100189215	KIT, SIGHT GLASS	WH 056 - 286
29	100163214	KIT, SIGHT GLASS	WH 400
30	100275564	GASKET, SIGHT GLASS - UPPER	WH 056 - 286
30	100233667	GASKET, SIGHT GLASS	WH 400
31	100275566	GASKET, SIGHT GLASS - LOWER	WH 056 - 286
32	100287113	MIRROR, SIGHT GLASS	WH 056 - 286
32	100287112	MIRROR, SIGHT GLASS	WH 400
33	100268111	KIT, HEAT EXCHANGER TOP PLATE	WH 056 - 086
33	100268112	KIT, HEAT EXCHANGER TOP PLATE	WH 111 - 156
33	100268113	KIT, HEAT EXCHANGER TOP PLATE	WH 200 - 286
33	100173754	KIT, HEAT EXCHANGER TOP PLATE	WH 400
34	100287111*	GASKET, HEAT EXCHANGER TOP PLATE	WH 056 - 086
34	100287096*	GASKET, HEAT EXCHANGER TOP PLATE	WH 111 - 156
34	100287094*	GASKET, HEAT EXCHANGER TOP PLATE	WH 200 - 286
34	100278095	GASKET SET (BURNER, HEAT EXCHANGER, SIGHT GLASS - LOWER)	WH 400
35	100267965	BURNER W/ GASKETS	WH 056 - 086
35	100267967	BURNER W/ GASKETS	WH 111 - 156
35	100267968	BURNER W/ GASKETS	WH 200 - 286
35	100135269	BURNER W/ GASKETS	WH 400
36	100287092*	GASKET, BURNER	WH 056 - 086
36	100287091*	GASKET, BURNER	WH 111 - 156
36	100287090*	GASKET, BURNER	WH 200 - 286
36	100278095	GASKET SET (BURNER, HEAT EXCHANGER, SIGHT GLASS - LOWER)	WH 400
37	100287088	INSULATION, BURNER	WH 056 - 086
37	100287087	INSULATION, BURNER	WH 111 - 156
37	100287086	INSULATION, BURNER	WH 200 - 286
37	100287085	INSULATION, BURNER	WH 400
MISCELLANEOUS			
38	100287082	WATER PIPE, INLET	WH 056 - 086
38	100287080	WATER PIPE, INLET	WH 111 - 156
38	100287079	WATER PIPE, INLET	WH 200 - 286
38	100287078	WATER PIPE, INLET	WH 400
39	100287077	WATER PIPE, OUTLET	WH 056 - 086

PLEASE HAVE MODEL AND SERIAL NUMBER WHEN ORDERING PARTS
*ITEMS DENOTE SUGGESTED INVENTORY PARTS

ITEM NO.	PART NO.	DESCRIPTION	MODEL
MISCELLANEOUS (CONTINUED)			
39	100287075	WATER PIPE, OUTLET	WH 111 - 156
39	100287074	WATER PIPE, OUTLET	WH 200 - 286
39	100287073	WATER PIPE, OUTLET	WH 400
-	100287071	GASKET, WATER TUBE	WH 056 - 156
-	100278051	GASKET, WATER TUBE	WH 200 - 286
-	100287067	GASKET, WATER TUBE	WH 400
40	100284286	CONDENSATE TRAP ASSEMBLY	ALL
-	100287066	PIPE, CONDENSATE TRAP	ALL
41	100287064	FLUE CONNECTION PIPE, 2" CPVC	WH 056 - 086
41	100287038	FLUE CONNECTION PIPE, 3" CPVC	WH 111 - 286
41	100287036	FLUE CONNECTION PIPE, 4" CPVC	WH 400
-	100287029	TEE, 2" CPVC W/ ANALYZER PORT	WH 056 - 086
-	100287027	TEE, 3" CPVC W/ ANALYZER PORT	WH 111 - 286
-	100208449	VALVE, RELIEF - 30 PSI	WH 056 - 286
-	100284289	VALVE, RELIEF - 30 PSI	WH 400
-	100287083	VALVE, COIN VENT - 150 PSI	ALL
-	100208152	GAUGE, TRIOMETER - 75 PSI, 210°F	ALL
-	100163203	SCREEN, BIRD - 2" SS	WH 056 - 086
-	100163204	SCREEN, BIRD - 3" SS	WH 111 - 286
-	100163205	SCREEN, BIRD - 4" SS	WH 400
-	100157775*	KIT, SYSTEM SENSOR	ALL
-	100208834*	KIT, OUTDOOR AIR SENSOR	ALL
-	100286988	HARNESS, UNIT	WH 056 - 286
-	100286987	HARNESS, UNIT	WH 400
-	100286984	HARNESS, POWER	WH 056 - 286
-	100286983	HARNESS, POWER	WH 400
-	100208620	HARNESS, IGNITOR	WH 056 - 286
-	100284234	HARNESS, IGNITOR	WH 400
-	100278061	HARNESS, FLAME SENSOR	ALL
-	100286981	HARNESS, CONNECTION BOARD	ALL
-	100208636	HARNESS, RIBBON CABLE	ALL
-	100208637	HARNESS, GAS VALVE	WH 400
-	100208808	FUSE, 1.25A / 250V	ALL
-	100208231	FUSE, 3.15A / 250V	ALL
-	100290102	FUSE, 6.3A / 250V	ALL
-	100268040	KIT, LP CONVERSION	WH 056
-	100268104	KIT, LP CONVERSION	WH 086
-	100285815	KIT, LP CONVERSION	WH 111
-	100285817	KIT, LP CONVERSION	WH 156
-	100285818	KIT, LP CONVERSION	WH 200
-	100268109	KIT, LP CONVERSION	WH 286
-	100159011	KIT, LP CONVERSION	WH 400
42	100286989	BRACKET, WALL MOUNT	ALL
PUMPS			
-	100277713	PUMP, 115V, 1/25 HP, 3 SPEED	WH 056 - 156
-	100277714	PUMP, 115V, 1/6 HP, 3 SPEED	WH 200 - 286
-	100166414	PUMP, 115V, 1/6 HP, 3 SPEED	WH 400
JACKET ASSEMBLIES			
43	100286959	BEZEL, DISPLAY	WH 056 - 286
43	100286957	BEZEL, DISPLAY	WH 400
44	100286881	KIT, DISPLAY BEZEL ASSEMBLY	WH 056 - 286
44	100286882	KIT, DISPLAY BEZEL ASSEMBLY	WH 400
45	100286955	JACKET, OUTER FRONT DOOR ASSEMBLY	WH 056 - 286
45	100286954	JACKET, OUTER FRONT DOOR ASSEMBLY	WH 400
46	100286953	JACKET, TOP FRONT	WH 056 - 086
46	100286950	JACKET, TOP FRONT	WH 111 - 156
46	100286948	JACKET, TOP FRONT	WH 200
46	100286943	JACKET, TOP FRONT	WH 286
47	100286941	JACKET, TOP BACK	WH 056 - 086

PLEASE HAVE MODEL AND SERIAL NUMBER WHEN ORDERING PARTS
*ITEMS DENOTE SUGGESTED INVENTORY PARTS

ITEM NO.	PART NO.	DESCRIPTION	MODEL
JACKET ASSEMBLIES (CONTINUED)			
47	100286918	JACKET, TOP BACK	WH 111 - 156
47	100286916	JACKET, TOP BACK	WH 200
47	100286912	JACKET, TOP BACK	WH 286
-	100286910	JACKET, TOP	WH 400
48	100286909	JACKET, LEFT SIDE PANEL	WH 056 - 086
48	100286907	JACKET, LEFT SIDE PANEL	WH 111 - 200
48	100286903	JACKET, LEFT SIDE PANEL	WH 286
48	100286901	JACKET, LEFT SIDE PANEL	WH 400
49	100286899	JACKET, RIGHT SIDE PANEL	WH 056 - 086
49	100286897	JACKET, RIGHT SIDE PANEL	WH 111 - 200
49	100286894	JACKET, RIGHT SIDE PANEL	WH 286
49	100286891	JACKET, RIGHT SIDE PANEL	WH 400

PLEASE HAVE MODEL AND SERIAL NUMBER WHEN ORDERING PARTS
*ITEMS DENOTE SUGGESTED INVENTORY PARTS

NOTES

