



**Copper-Fin II®
VENTING OPTIONS
Submittal Sheet**

CFIIVOA-Sub-10

**COPPER-FIN II® VENTING OPTIONS
CF/CH/CP 402-752 WATER HEATER, BOILERS, POOL HEATERS**

JOB NAME _____ LOCATION _____
ENGINEER _____ MODEL NO. _____
MECH. CONTRACTOR _____

DIRECTAIRE™ VERTICAL VENTING

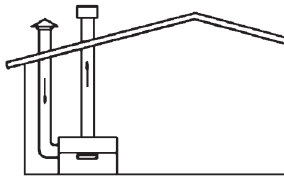

ALL WEATHER
AIR INLET CAP

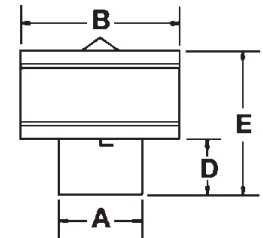
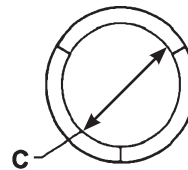

Models 402-752

Lochinvar supplies the air inlet connection to the jacket and the All Weather Air Inlet Cap. Contractor to supply Type "B" vent pipe material, exhaust vent cap on heater flue and single wall air inlet pipe. Maximum air inlet length 50 equivalent feet.

KIT NO.	MODEL	A	B	C	D	E
VDK3026	CF/CH/CP 402-502	6"	10-1/2"	8-1/2"	3-1/4"	8-1/4"
VDK3027	CF/CH/CP 652-752	8"	12-1/2"	10"	3-1/4"	8-1/4"

DIRECTAIRE™ VERTICAL W/ SIDEWALL INLET

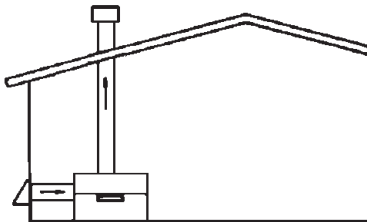

AIR INLET /
EXHAUST CAP

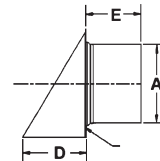
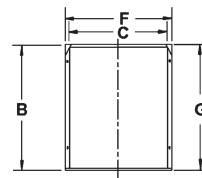

Models 402-752

Lochinvar supplies the air inlet connection to the jacket and Air Inlet Cap. Contractor to supply Type "B" vent pipe material from heater to vent outlet and single wall air inlet pipe. Maximum air inlet length 50 equivalent feet.

KIT NO.	MODEL	A	B	C	D	E	F	G
SVK3047	CF/CH/CP 402-502	6"	9"	8"	4-1/2"	2-1/2"	9"	8-1/2"
SVK3048	CF/CH/CP 652-752	8"	12"	11"	7"	2-1/2"	12"	11-1/2"

POWERED SIDEWALL VENTING

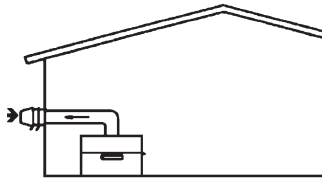

MODELS 402-752

Lochinvar supplies Powered Vent Cap and Proving Switch. Contractor to supply Type "B" vent pipe material from heater to vent outlet. 120 VAC (4.37 running amp load) required to operate vent cap. Maximum vent length 100 equivalent feet.

POWERED VENT CAP

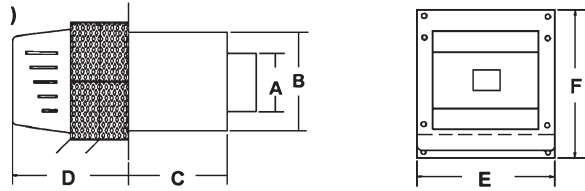

KIT NO.	MODEL	A	B	C	D	E	F
SVK3006	CF/CH/CP 402-502	6"	8"	9-1/8"	10-3/4"	10-5/8"	12-1/4"
SVK3008	CF/CH/CP 652-752	8"	10"	9-1/8"	11-7/8"	13"	14-1/4"

POWER DIRECTAIRE™ HORIZONTAL VENTING

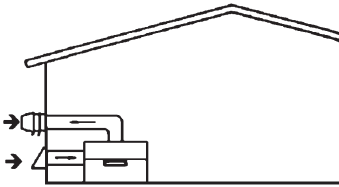

MODELS 402-752

Lochinvar supplies Powered Vent Cap, Proving Switch, Air Inlet Cap and air inlet connection to jacket. Contractor to supply Type "B" vent pipe material from heater to vent outlet and single wall air inlet pipe. 120 VAC (4.37 running amp load) required to operate Vent Cap. Maximum air inlet and vent length 100 equivalent feet.

POWERED VENT CAP

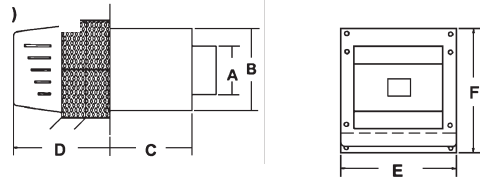

KIT NO.	MODEL	A	B	C	D	E	F
HDK3031	CF/CH/CP 402-502	6"	8"	9-1/8"	10-3/4"	10-5/8"	12-1/4"
HDK3032	CF/CH/CP 652-752	8"	10"	9-1/8"	11-7/8"	13"	14-1/4"

AIR INLET CAP

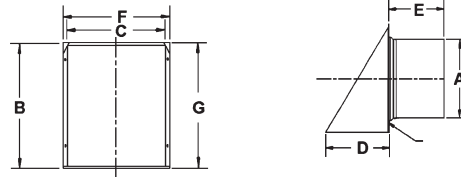

FOR MODEL	A	B	C	D	E	F	G
CF/CH/CP 402-502	6"	9"	8"	4-1/2"	2-1/2"	9"	8-1/2"
CF/CH/CP 652-752	8"	12"	11"	7"	2-1/2"	12"	11-1/2"

AireLOCK™ DIRECT VENT

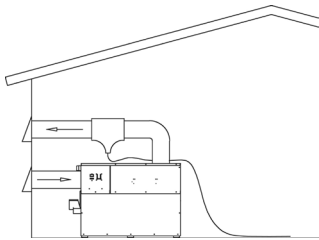

MODELS 402-752

Lochinvar supplies the air inlet connection in the jacket, Air Inlet Cap and exhaust cap. Contractor to supply Category IV approved vent pipe material and air inlet pipe suitable for the installation environment. Maximum air inlet and vent length 50 equivalent feet.

AIR INLET /EXHAUST CAP

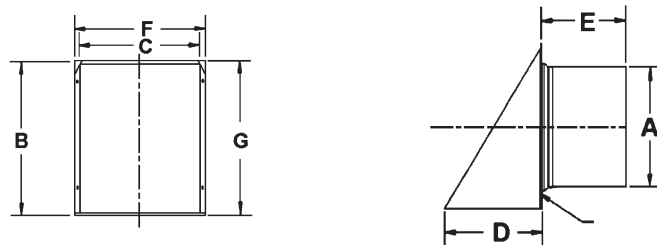

KIT NO.	MODEL	A	B	C	D	E	F	G
DVK3004	CF/CH/CP 402-502	6"	9"	8"	4-1/2"	2-1/2"	9"	8-1/2"
DVK3005	CF/CH/CP 652-752	8"	12"	11"	7"	2-1/2"	12"	11-1/2"

SIDEWALL VENTING

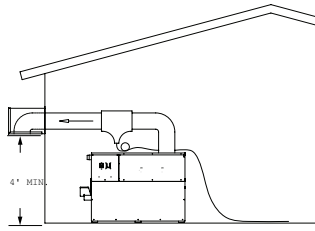

Models 402-752

Lochinvar supplies exhaust cap and vent adapter. Contractor to supply Category IV approved vent pipe material. Maximum vent length 50 equivalent feet

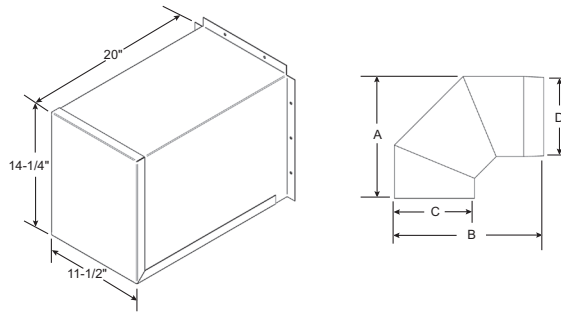

KIT NO.	MODEL	A	B	C	D
SVK3043	CF/CH/CP 402-502	9-1/8"	11-1/8"	6"	5-7/8"
SVK3044	CF/CH/CP 652-752	14-1/4"	16"	8"	7-7/8"

OUTDOOR VENTING

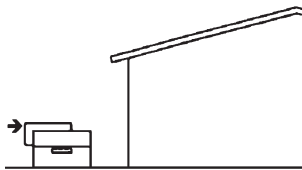

Models 402-752

Lochinvar supplies the Outdoor Vent Cap with sealing gaskets to mount directly on the unit. The cap properly vents flue products out of the unit and provides a weather proof combustion air inlet on outdoor installations.

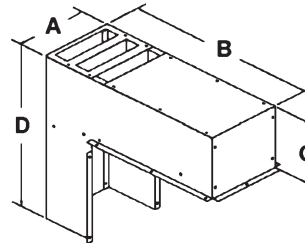

KIT NO.	MODEL	A	B	C	D
ODK3052	CF 402-502	15"	22-1/4"	10"	26"
ODK3053	CF 652-752	15"	22-1/4"	10"	26"
ODK3748	CH 402-502	15"	22-1/4"	10"	26"
ODK3749	CH 652-752	15"	22-1/4"	10"	26"
ODK3075	CP 502	15"	22-1/4"	10"	26"
ODK3076	CP 651-751	15"	22-1/4"	10"	26"

Water Heater ODKs include vent cover and pump cover.

Boiler ODKs include vent cover.

Pool Heater ODKs include vent cover and bypass valve cover.



Lochinvar, LLC
300 Maddox Simpson Parkway
Lebanon, Tennessee 37090
P: 615.889.8900 / F: 615.547.1000
f t in o Lochinvar.com

