

EnergyRite²[®]

Lochinvar[®]



The Right Choice for Pool and Spa Heating

88% THERMAL EFFICIENCY



EnergyRite²

Lochinvar

The Right Choice for Pool & Spa Heating

- **Fastest Heat Up Time in the Industry**
- **Commercial Grade Construction**
- **Comfort In Mind and Body**



Faster Heat Up Time, Plus Higher Efficiency Equates to Lower Operating Costs

With efficiencies of up to 88%, the EnergyRite² will make an immediate impact by lowering your monthly fuel bill! With the EnergyRite², 88 cents from each fuel dollar is used for what is intended – heating water. EnergyRite² heats the pool water faster with energy saving performance.

Quality Built-In

Built to commercial grade standards, EnergyRite² pool heaters are better designed and better built. The rust free water surfaces are completely lined with a molecularly molded porcelain glass mixture, extending the performance of your pool heater. Its gasket free, copper finned tube heat exchanger is the only one in its class - eliminating leaks and failures common with similar models, while providing years of efficient operation. And every EnergyRite² pool heater is quality checked throughout the manufacturing process, giving you a pool heater built to a higher standard.



Protecting the Environment – Now and for Future Generations

The Lochinvar EnergyRite² is one of the most environmentally friendly pool heaters on the market today. With NOx emissions less than 20 ppm, it exceeds the stringent low NOx emissions standards of Texas and of California's South Coast Air Quality Management Districts. The EnergyRite² not only complies with the current emissions standard – it also meets the more restrictive NOx limitations proposed for the future.



Relax and Enjoy

Lochinvar quality is backed with a comprehensive 3/2 limited warranty, providing 3 full years of protection on the heat exchanger and 2 full years on parts. Enjoy your pool or spa investment and relax knowing that it's heated by Lochinvar!

Venting Solutions

Installation is Made Easy

The Lochinvar EnergyRite² offers multiple venting options that can save time and money during installation - indoors or outdoors. With the flexibility of venting either horizontally or vertically, installations become a snap.

* Indicates factory vent kit required

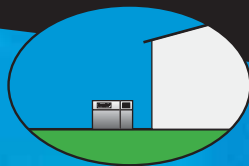

Outdoor
Standard from factory. Use when indoor space is insufficient or if outdoor location provides better access.

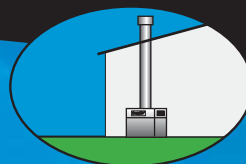

Conventional*
Vents into conventional vertical flue or vent breaching using Type B double wall vent.



E-Rite™ Side Wall*
Draws fresh combustion air horizontally through outside wall, and vents by-products horizontally up to 20 equivalent feet through outside wall using Category IV type vent.

Reliability by Design



Comfort with Digital Accuracy

The user friendly design allows fingertip access of temperature settings. Its programming menu guarantees total comfort while providing the ability to switch from pool to spa control.

Heavy Duty, Gasketless Heat Exchanger

Lochinvar's high-efficiency, copper finned tube, gasketless heat exchanger design enhances reliability, durability and performance, while eliminating the leaks and failures common with O-rings and gaskets. And all EnergyRite² heat exchangers are built to the same ASME* construction standard as large commercial grade pool heaters. (*ASME certification is available as an option.)

Environmentally Friendly

High efficiency stainless steel burners ensure precise mixture of gas and air for clean combustion and a cleaner environment.

"Safety-Seal" Combustion Chamber

Completely sealed to keep out wind and ensure safe operation, it also helps to keep out wasp nests, spiders and other pests. And the outer jacket is made of heavy duty galvanized, pre-painted steel – stronger than other heaters in its class!

"Fail Safe" Ignition System

Utilizes hot surface ignition and "Smart Valve" controls for comfort assurance. Hot surface ignition is more reliable than spark or pilot ignition, guaranteeing a heated pool/spa when you need it. And the "Smart Valve" controls optimize performance and efficiency by ensuring the proper mixture of fuel and air for a "Fail Safe" Ignition System.

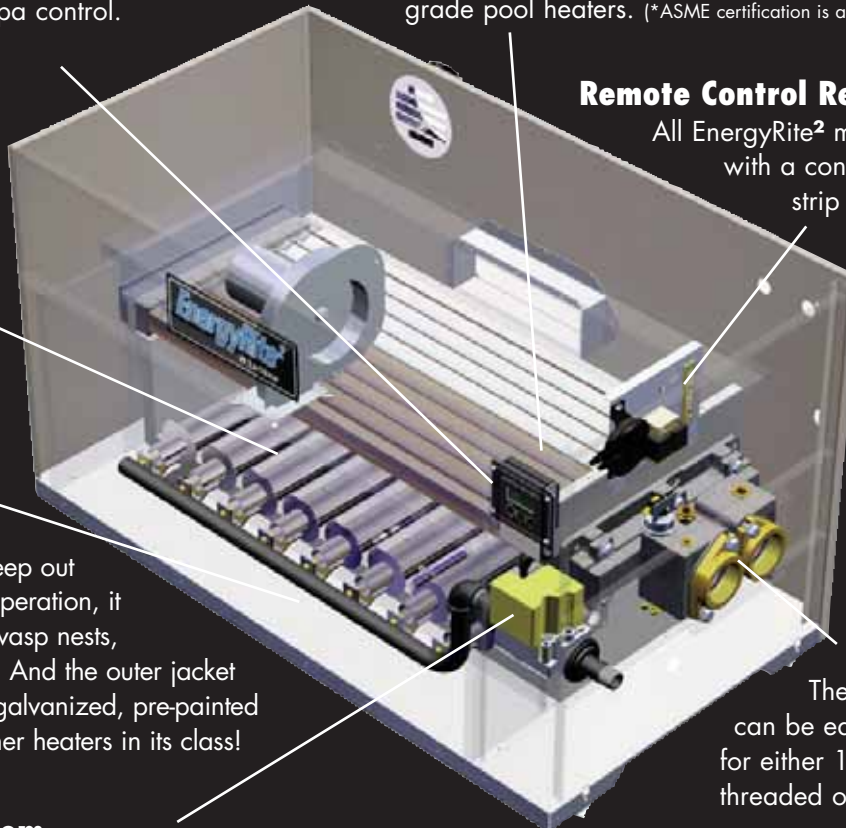

Remote Control Ready

All EnergyRite² models come equipped with a convenient 24-volt terminal strip for fast and easy connection to optional remote controls, purchased separately.

Simple, Convenient Connections

Pipe directly to the heater with PVC or CPVC materials lowering your installation costs.

The flanged connections can be easily adapted for either 1-1/2" or 2" pipe, threaded or slip-fit connections.

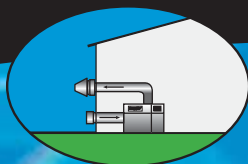

Power DirectAire® Horizontal*
Draws fresh combustion air horizontally through outside wall, and vents by-products horizontally up to 75 equivalent feet through outside wall using powered vent cap.

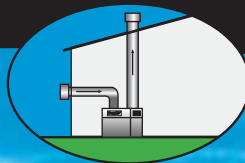

DirectAire® Vertical w/Sidewall Inlet*
Draws fresh combustion air horizontally through outside wall, and vents combustion by-products through a vertical flue.

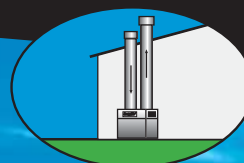

DirectAire® Vertical w/Rooftop Inlet*
Draws fresh combustion air vertically through roof, and vents combustion by-products through conventional vertical flue.

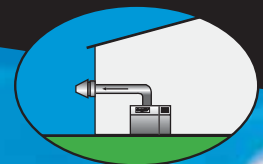

Powered Side Wall*
Draws fresh combustion air from inside the room, and vents by-products horizontally up to 75 equivalent feet through outside wall using powered vent cap.

EnergyRite² Dimensions

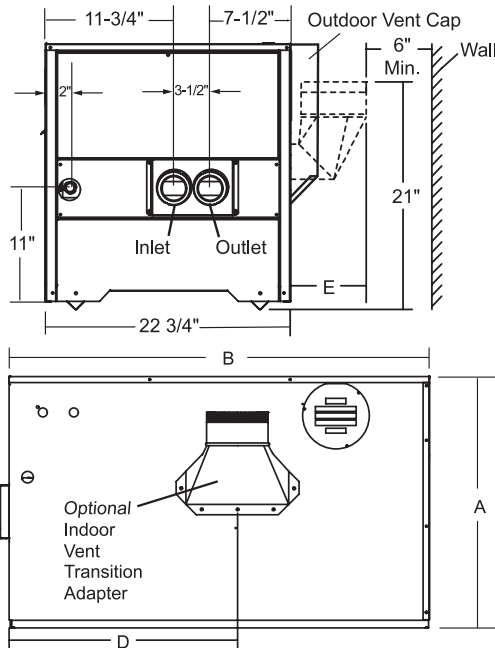

MODEL NUMBER	Btu/hr INPUT	Btu/hr OUTPUT	INTAKE	VENT	SHIPPING WEIGHT
ERN151	150,000	132,000	4"	5"	235
ERN201	199,999	175,999	4"	5"	255
ERN251	250,000	220,000	4"	5"	275
ERN301	300,000	264,000	5"	5"	290
ERN401	399,999	351,999	5"	6"	315

*Note: Change "N" to "L" for LP Gas Models. No deration for LP on outdoor applications. Output based on 88% thermal efficiency. Water connections 2" NPT.

MODEL NUMBER	A	B	D	E	GAS CONN.
ERN151	24-3/4"	23"	12-1/2"	6"	3/4"
ERN201	24-3/4"	26-1/2"	14-3/4"	6"	3/4"
ERN251	24-3/4"	30-1/4"	17"	6"	3/4"
ERN301	24-3/4"	33-3/4"	18-1/2"	6-1/2"	3/4"
ERN401	24-3/4"	41"	22-1/4"	7"	3/4"

Standard Features

- 88% Thermal Efficiency
- Digital Temperature Control
- Gasketless Heat Exchanger
- CPVC or PVC Ready
- "Fail Safe" Ignition System
- Remote Control Ready
- Power Induced Blower
- Sealed Combustion Chamber
- Stainless Steel Burners
- Loch-Heat™ Ceramic Tile
- 24v Terminal Strip
- Built-in Air and Water Pressure Switches
- Glass-Lined, Cast Iron Header with Built-in Bypass
- Low NOx Emissions Meet the Most Stringent Standards
- Outdoor Venting
- 3 Year Limited Warranty on Heat Exchanger
- 2 Year Limited Warranty on Parts (see warranties for details)

Optional Equipment

- Cupro-Nickel Heat Exchanger
- Alarm Bell
- ASME Certification
- Combustion Floor Shield
- ASME Relief Valve
- Indoor Venting Solutions

FOR EASE IN ORDERING

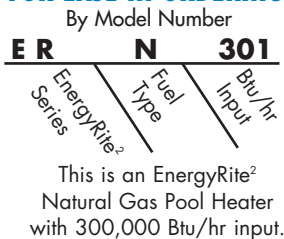

EnergyRite² Pool and Spa Sizing Guides

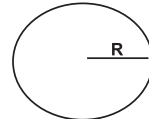

$$\text{AREA} = R \times R \times 3.14$$

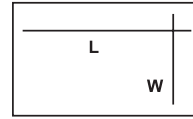

$$\text{AREA} = L \times W$$

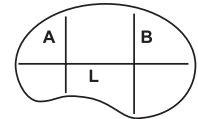

$$\text{AREA} = (A + B) \times L \times .45$$

Swimming Pool Sizing

- Determine your pool's surface area in square feet.
- Determine the desired temperature rise by subtracting the average air temperature from the desired pool temperature.
- In the table below locate the surface area equal to, or just greater than, your pool's surface area at the desired temperature rise.
- Read to the left for the appropriate EnergyRite² model number.

Model Number	POOL HEATER SIZING CHART				
	Desired Temperature Rise				
	10°F	15°F	20°F	25°F	30°F
	Pool Surface Area in Sq. Ft.				
ERN151	1257	838	629	503	419
ERN201	1676	1117	838	670	559
ERN251	2095	1397	1048	838	698
ERN301	2514	1676	1257	1006	838
ERN401	3352	2235	1676	1341	1117

NOTE: Sizing is based on a 3-1/2 MPH average wind velocity for elevations up to 2,000 feet above sea level. For each 1,000 feet above 2,000 feet elevation, add 4% to the surface area of the pool.

Spa and Hot Tub Sizing

- Determine your Spa/Hot tub's capacity in U.S. gallons by multiplying the surface area (in square feet) by the average depth (in feet), then by a conversion factor of 7-1/2. (1 ft³ = 7-1/2 gallons)
- The table lists the time required (in minutes) to raise the temperature of different size spa/hot tub's 30°F.
- In the table below locate the gallon capacity equal to or just greater than your spa/hot tub's size in gallons.
- Select the desired heat up time.
- Read to the left for the appropriate EnergyRite² model number.

Model Number	SPA & HOT TUB SIZING CHART									
	Spa/Tub Size in US Gallons									
	200	300	400	500	600	700	800	900	1000	
	Time (Minutes) required to raise temperature									
ERN151	23	34	45	57	68	80	91	102	114	
ERN201	17	26	34	43	51	60	68	77	85	
ERN251	14	20	27	34	41	48	55	61	68	
ERN301	11	17	23	28	34	40	45	51	57	
ERN401	9	13	17	21	26	30	34	38	43	

NOTE: Sizing is based on a 30°F temperature rise. To adjust for other temperature rises divide the time listed in the table by the temperature ratio. Example: for a 15°F temperature rise divide by 2 (30/15=2).



Lochinvar Corporation • 300 Maddox Simpson Pkwy • Lebanon, TN 37090 • 615-889-8900 / Fax: 615-547-1000

www.Lochinvar.com