

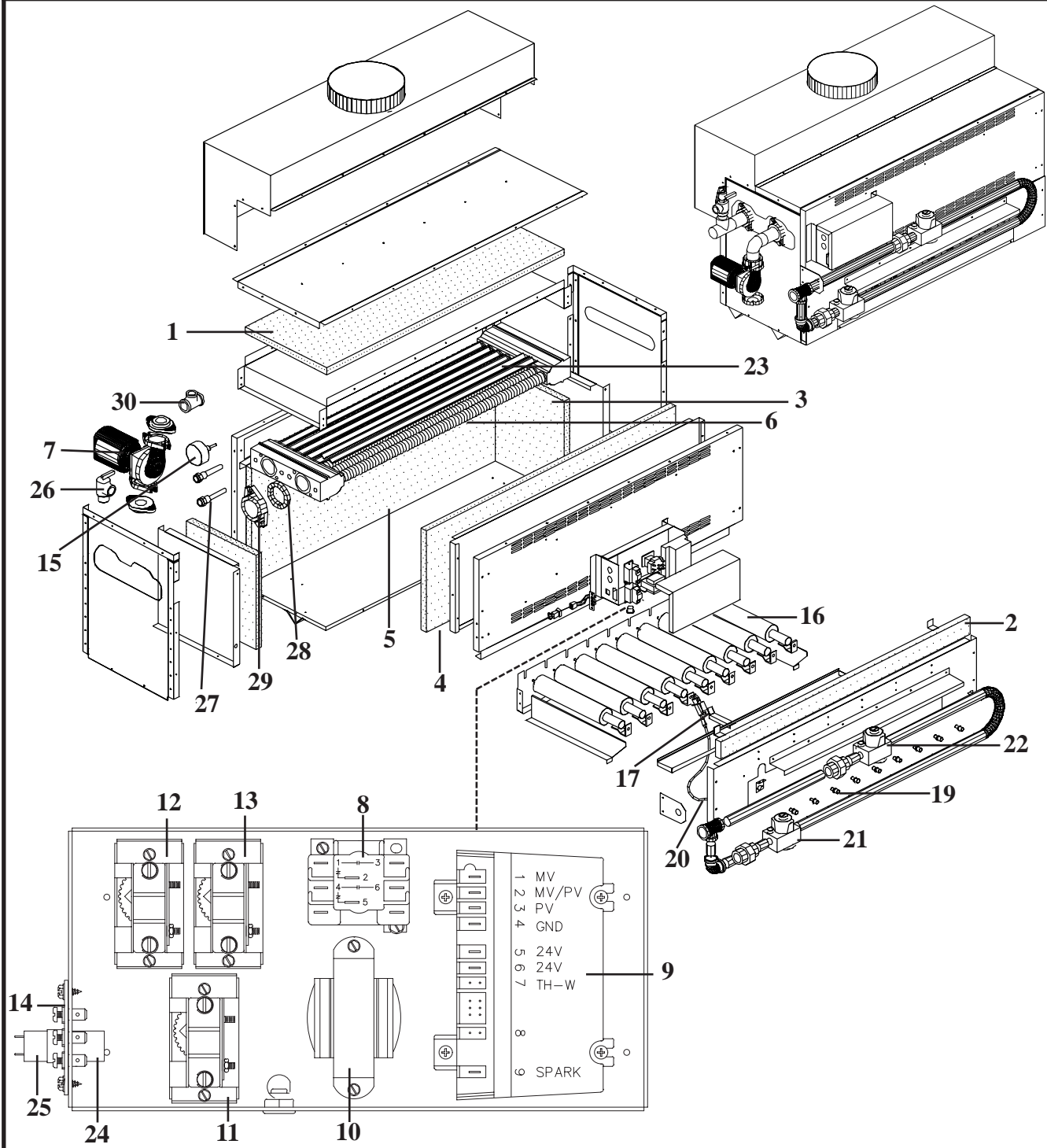

PARTS & SERVICE DEPARTMENT
 Nashville, Tennessee
 615-889-8900 / Fax: 615-547-1000
 www.Lochinvar.com

Replacement Parts List

**RB/RW
 399 — 500
 Boilers & Water Heaters**



ITEM NO.	PART NO.	DESCRIPTION	MODEL NO.
Loch-Heat® Tile			
1	FIB2938	LOCH-HEAT TILE, TOP	ALL 399
1	FIB2939	LOCH-HEAT TILE, TOP	ALL 500
2	FIB2934	LOCH-HEAT TILE, FILLER	ALL 399
2	FIB2935	LOCH-HEAT TILE, FILLER	ALL 500
3	FIB2900	LOCH-HEAT TILE, SIDE	ALL
4	FIB2936	LOCH-HEAT TILE, FRONT	ALL 399
4	FIB2937	LOCH-HEAT TILE, FRONT	ALL 500
5	FIB2940	LOCH-HEAT TILE, BACK	ALL 399
5	FIB2941	LOCH-HEAT TILE, BACK	ALL 500
Heat Exchangers			
6	HEX3812	HEAT EXCHANGER (RW, Before Serial # F00, and all RB)	399
6	HEX3813	HEAT EXCHANGER (RW, Before Serial # F00, and all RB)	500
6	HEX3040	HEAT EXCHANGER (After Serial # F00)	RW 399
6	HEX3041	HEAT EXCHANGER (After Serial # F00)	RW 500
23	JKR6307	V-BAFFLE	399
23	JKR6308	V-BAFFLE	500
Pumps			
7	ARM3045PBF	PUMP (Before Serial # L01)	ALL RW
7	ARM3045PAB	PUMP (After Serial # L01)	ALL RW
Controls			
8	RLY2042	RELAY PUMP (RW After Serial # L01 & All RB)	ALL
9	RLY2023	IGNITION MODULE	ALL
10	TRF2004	TRANSFORMER, 50V.A.	ALL
11	TST2902	OPERATOR	ALL RB
11	TST3920	OPERATOR	ALL RW
12	TST3910	LIMIT	ALL RW
13	TST3911	HI LIMIT	ALL
-	TST2026	REMOTE THERMOSTAT	ALL RW
14	MSC2320	TERMINAL BOARD	ALL
15	GTP2900	T & P GAUGE	ALL RB
15	GTP3000	TEMPERATURE GAUGE	ALL RW
Gas Train			
16	BNR2902	MAIN BURNER	ALL
17	PLT2905	PILOT BURNER NAT.	ALL
17	PLT2906	PILOT BURNER LPG. to S/N F993554	ALL
17	PLT2907	PILOT BURNER LPG. begin S/N F993554	ALL
19	ORF2904	ORIFICE, MAIN BNR. NAT.	ALL
19	ORF2901	ORIFICE, MAIN BNR. LPG.	ALL
20	WRE2031	IGNITION CABLE	ALL
21	VAL2928	GAS VALVE, NAT. W/PILOT VALVE	ALL
21	VAL2929	GAS VALVE, LPG. W/PILOT VALVE	ALL
22	VAL3403	GAS VALVE, NAT.	ALL
22	VAL3404	GAS VALVE, LPG.	ALL
Miscellaneous			
24	WRE2912	WIRE HARNESS (F-9 Control)	RB
24	WRE2921	WIRE HARNESS (F-9 Control)	RW
24	WRE2928	WIRE HARNESS (F-9 Control Dual Gas Valve)	ALL
25	WRE2915	JUMPER PLUG	ALL
26	RLV2001	RELIEF VALVE, PRESSURE ONLY	ALL RB
26	RLV2007	RELIEF VALVE, TEMPERATURE & PRESSURE	ALL RW
27	TST2301	BULB WELL	ALL
28	GKT2901	GASKET, FLANGE 11/2"	ALL RW
29	WTR3902	FLANGE, 11/2"	ALL RW
30	BRS3890	OUTLET TEE FOR ITEMS 15 & 26 (11/2" X 3/4" X 11/2")	ALL RW
--	TST2015	MANUAL RESET HIGH LIMIT	OPTIONAL
--	WTR2040	FLOW SWITCH	OPTIONAL
--	RLY2707	PUMP DELAY	RW
--	WTR2528	LOW WATER CUT OFF	OPTIONAL
--	WTR2532	PROBE FOR L.W.C.O.	OPTIONAL

PLEASE: Have model number and serial number when ordering parts.

NOTE: RB = BOILER & RW = WATER HEATER